

POTABLE WATER TANK LINING SYSTEM BASED
ON **HYPERDESMO[®]-2K-W.**



TABLE OF CONTENTS

| | |
|---|----|
| WHY CHOOSE ALCHIMICA IN TANK LINING WATERPROOFING PROJECTS? | 4 |
| ALCHIMICA’S POLYURETHANE LIQUID MEMBRANES | 7 |
| UNDERSTANDING TANK LINING SYSTEMS | 9 |
| EN 1504-2 | 12 |
| THE PURPOSE OF DRINKING/POTABLE WATER CERTIFICATION | 13 |
| PREPARATION..... | 16 |
| REPAIR AND LEVELING MORTARS | 17 |
| PRIMER SELECTION | 18 |
| SEALING SOLUTIONS | 18 |
| METHOD STATEMENT | |
| <hr/> | |
| GENERAL SYSTEM CONDITIONS | 22 |
| SYSTEM PRODUCTS BUILD-UP | 26 |
| SUBSTRATE PRIMING..... | 28 |
| DILATATION JOINTS, INNER ANGLES & SMALL CRACKS | 30 |
| MAIN WATERPROOFING MEMBRANE..... | 34 |
| TOPCOAT | 35 |
| CLEANING | 35 |
| REPAIR AND MAINTENANCE PROCESSES | 37 |
| REFERENCES | 38 |
| HEALTH AND SAFETY | 39 |
| PRECAUTIONS AND VARIATIONS. | 39 |
| LEGAL NOTES AND CITATION | 39 |

WHY CHOOSE ALCHIMICA IN TANK LINING WATERPROOFING PROJECTS?

When it comes to tank lining systems, the choice of product can significantly impact the durability, safety, and efficiency of storage tanks. ALCHIMICA's HYPERDESMO-2K-W is a leading solution in this field, offering an effective, versatile, and reliable system for various tank applications. HYPERDESMO-2K-W is a two-component, solvent-free, thixotropic polyurethane coating designed for tank lining systems waterproofing and protection. Its advanced formulation provides a strong, elastic, and hydrophobic membrane that ensures exceptional performance across various conditions.

One of the key benefits of using HYPERDESMO-2K-W is its excellent chemical resistance. The coating exhibits robust resistance to a wide range of chemicals, making it ideal for tanks storing aggressive substances. This includes resistance to acids, bases, industrial detergents, and seawater, ensuring long-lasting protection even in harsh environments. This chemical resilience makes HYPERDESMO-2K-W a reliable choice for various industrial applications such as chemical storage tanks, wastewater treatment tanks, and desalination tanks. For specific chemical resistance properties and tank content requirements, please contact alchimica@alchimica.com for approval.

Additionally, HYPERDESMO-2K-W is highly versatile. It can be applied to different substrates with the appropriate primers. For example, AQUADUR/AQUASMART-DUR is used as a primer for concrete surfaces, providing a robust barrier against moisture and negative pressure, ensuring optimal adhesion of the HYPERDESMO-2K-W membrane. This flexibility allows the product to be suitable for various applications, including potable water tanks, wastewater treatment tanks, and chemical storage tanks. Other primers are available for a variety of substrates to secure adhesion and protect the tank structure. Consult the Primer Selection Table and product TDS for more information. This adaptability ensures that the specific needs of each tank type are met efficiently.

Furthermore, HYPERDESMO-2K-W is certified for use in potable water tanks, meeting the stringent requirements of European Union guidelines 98/83/EC. It has been tested

and approved for its safety and efficacy in contact with drinking water, providing peace of mind for applications requiring high purity standards. This certification underscores the product's reliability and suitability for applications involving the storage of drinking water.

The ease of application of HYPERDESMO-2K-W is another significant advantage. The product's application process is straightforward, involving mixing the two components and applying them in one or two coats. The membrane cures quickly, forming a durable, seamless barrier that is resistant to structural movements and environmental stressors. This simplicity in application not only saves time but also ensures consistent and reliable performance across different projects.



Different tank types have specific requirements based on their contents and usage. ALCHIMICA's HYPERDESMO-2K-W, along with its range of primers and topcoats, effectively meets these varied needs. For potable water applications, the use of HYPERDESMO-2K-W ensures compliance with health and safety regulations. Its certification by institutions such as O.T.E.C. confirms its suitability for storing drinking water without compromising quality. It has been certified for EU regulations by the O.T.E.C. institute and by the Standards Institution of Israel, according to the regulations of Australia and New Zealand, and the Water Supply Regulations of England, Wales, Ireland, and Scotland through the Water Regulation Advisory Scheme (WRAS). More importantly, while creating HYPERDESMO-2K-W, all possible drinking water limitations and specifications globally were considered to create a product that could be used under any regulations, everywhere. It has excellent thixotropy and rheology without being viscous; it cures fast and remains flexible in a multitude of temperatures. Extremely hydrophobic and hydrolysis-resistant, it has already been used for the waterproofing of many potable water applications as well as in water desalination plants globally. This ensures that water stored in these tanks remains safe for consumption, meeting stringent purity standards.

Wastewater treatment tanks require linings that can withstand the corrosive nature of sewage and industrial wastewater. HYPERDESMO-2K-W offers robust chemical resistance and durability, preventing leaks and prolonging the life of the tanks. This resistance is crucial in maintaining the integrity of the tanks under constant exposure to harsh wastewater environments. Chemical storage tanks demand a lining system that can resist corrosion and chemical attack. HYPERDESMO-2K-W's proven resistance to a broad spectrum of chemicals makes it an excellent choice for these applications. Its durability ensures safety and reliability, protecting the tank from aggressive substances and preventing potential leaks or spills that could lead to environmental contamination. Desalination tanks, used to remove salt and minerals from seawater, require linings that are highly resistant to saline environments. HYPERDESMO-2K-W's resistance to both saline and chemically aggressive environments make it ideal for both pre-treatment and post-treatment desalination processes. This ensures that the tanks maintain their integrity and functionality despite the harsh conditions they are subjected to during the desalination process.

Overall, ALCHIMICA's HYPERDESMO-2K-W, supported by appropriate primers and topcoats, provides tailored solutions for different tank types, ensuring that each application meets its specific requirements efficiently and effectively.

HYPERDESMO-2K-W has a track record of proven performance in numerous large-scale projects around the world. Its robust formulation and reliable application have been demonstrated in diverse environments, from desalination plants to wastewater treatment facilities across Europe. The product's durability and effectiveness in these demanding applications underscore its reliability and suitability for a wide range of tank lining needs.

Regular maintenance is crucial to ensure the longevity and performance of tank linings. ALCHIMICA provides comprehensive guidelines for the maintenance and repair of HYPERDESMO-2K-W coated tanks. Periodic inspections should be conducted to check for any signs of wear or damage. If repairs are needed, the affected areas should be cleaned thoroughly, and a fresh coat of HYPERDESMO-2K-W should be applied following the recommended procedures. Ensuring proper ventilation

throughout the tank's life can also hinder the formation of microorganisms that might damage the underlying concrete.

Choosing ALCHIMICA's tank lining systems, particularly the HYPERDESMO-2K-W, represents a strategic investment in the long-term reliability and efficiency of tank and storage infrastructure. The system's ease of application, versatility, and robust performance across different environments make it a superior choice for various industrial needs. By selecting ALCHIMICA's tank lining systems, companies not only protect their assets and the environment but also enhance operational efficiency, reduce maintenance costs, and ensure compliance with regulatory standards. Staying informed about the latest advancements in tank lining technologies and collaborating with experts to tailor solutions to specific requirements will further ensure the optimal performance and longevity of storage tanks. For more information on how ALCHIMICA's HYPERDESMO-2K-W can meet your tank lining needs, and to discuss your specific project requirements, contact ALCHIMICA at alchimica@alchimica.com. The team at ALCHIMICA is ready to provide expert guidance and support, ensuring that you select the most suitable lining system for your application.

ALCHIMICA is a pioneer and a global leader in complete polyurethane waterproofing solutions. With pedigree and expertise in this field, ALCHIMICA overcomes the challenges that others deem impossible. The technological depth and know-how of ALCHIMICA allow the formulation of innovative PU-based materials that can achieve performance levels that are not typically met. ALCHIMICA has been active in the research, development, and production of building chemicals for 42 years providing solutions for liquid waterproofing, reparations, sealing, flooring, and ETICs. The know-how of ALCHIMICA in Research and Development laboratories in construction, repair, and renovation solutions of buildings and infrastructure meets international industry standards.

ALCHIMICA'S POLYURETHANE LIQUID MEMBRANES

To ensure effective waterproofing, it is crucial to select PU membranes that meet specific criteria: impermeability, flexibility, durability, breathability, and resistance to environmental factors such as UV radiation, heat, humidity, and chemical exposure.

ALCHIMICA is a leader in the waterproofing industry, pioneering the use of liquid applied polyurethane membranes. With a commitment to high performance and durability, ALCHIMICA's products excel in applications where seamless systems are paramount, whether for structural integrity or aesthetic appeal. These membranes offer decisive advantages, particularly in complex scenarios like geometrically complicated connections with ventilation outlets or upturns.

Throughout its history, ALCHIMICA has continuously expanded its range of polyurethane liquid membranes to provide versatile installation alternatives and long-lasting solutions. From one and two-component polyurethane liquid membranes to bitumen-extended polyurethanes, water-based liquid polyurethane membranes, and advanced technology polyurethane dispersion (PUD) products, each solution is meticulously designed to address a wide array of waterproofing challenges with optimal performance and durability.

 **FULL COVERAGE AT EDGE**



ALCHIMICA's liquid membranes offer durability upon application, elasticity to withstand various stresses and traffic, and resistance to chemicals, and ponding water. These properties meet stringent technical

specifications, making them suitable for a diverse range of applications. The core objective of ALCHIMICA is to develop waterproofing systems that are competitive, simple to apply, and accessible to all professionals. By prioritizing ease of application and reliability, ALCHIMICA empowers users to achieve effective waterproofing solutions efficiently and effectively. The membranes are seamless, durable, and flexible and provide superior waterproofing performance, waterproof and moisture permeable, preventing water penetration, allowing moisture to escape, and reducing the risk of degradation and failure over time. With mechanical, thermal, and chemical resistance properties and breathability, ALCHIMICA's PU membranes ensure the longevity and efficiency of waterproofing systems.

ALCHIMICA's commitment to innovation and excellence has revolutionized waterproofing technologies globally. With a comprehensive range of polyurethane liquid membranes tailored to meet the demands of modern construction projects, ALCHIMICA remains the premier choice for effective, long-lasting waterproofing solutions.

UNDERSTANDING TANK LINING SYSTEMS

Tank lining systems are specialized coatings applied to the interior surfaces of storage tanks to provide a protective barrier against various damaging factors. These systems play a crucial role in maintaining the integrity and functionality of tanks, which are used in a wide range of industries for storing water, chemicals, and other materials. The importance of selecting a suitable tank lining system cannot be overstated, as it directly impacts the safety, durability, and efficiency of the tank.

Tank lining systems are essential for several reasons. Primarily, they protect the tank material from corrosion, which is particularly important for metal/steel tanks exposed to water and other corrosive substances. By preventing corrosion, the lining extends the lifespan of the tank, reducing the need for frequent replacements and repairs. Additionally, tank linings help to prevent leaks, which can lead to environmental contamination, loss of valuable contents, and costly clean-up operations. Moreover, tank linings are designed to be resistant to chemicals, ensuring that the stored substances do not react with the tank material. This is especially critical in tanks storing hazardous or aggressive chemicals. For potable water tanks, the lining must be non-toxic and approved for contact with drinking water to ensure the safety of the water supply. The lining also aids in maintaining the structural integrity of the tank by providing a barrier against physical damage and wear.

KEY COMPONENTS TO CHECK BEFORE CHOOSING A TANK LINING SYSTEM

When selecting a tank lining system, several important components need to be evaluated to ensure the best choice is made for the specific application. Compatibility with the stored content is paramount; the lining must be able to resist the chemical nature of the substances stored within the tank.

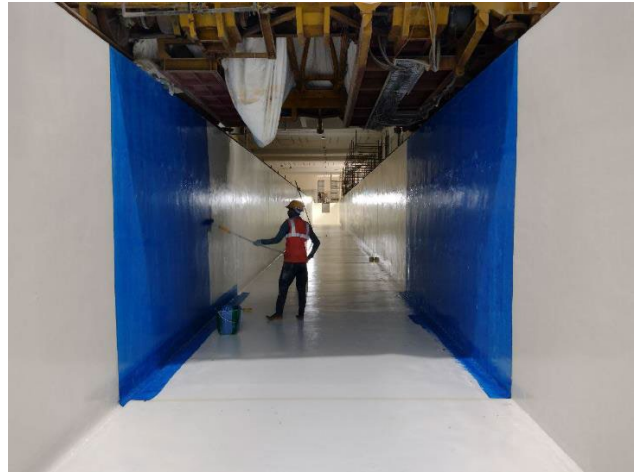

Environmental conditions, such as temperature extremes, humidity, and UV exposure, should also be considered to ensure the lining can withstand these factors without degrading.

The durability and longevity of the lining are critical to avoid frequent maintenance and ensure the tank remains operational for its intended lifespan. Regulatory compliance is another essential factor, as many industries have strict guidelines for storage tanks, particularly those storing hazardous materials or potable water. Ease of application is also important; the lining should be practical to apply within the specific tank configuration and installation environment to minimize downtime and labor costs. Additionally, the lining should offer good adhesion to the tank surface and be flexible enough to accommodate any movements or expansions of the tank material without cracking or peeling.

DIFFERENT TANK TYPES AND THEIR SPECIFIC NEEDS

WATER STORAGE TANKS

Water storage tanks are used for various purposes, from general storage for irrigation and firefighting to storing potable water. For general water tanks, the lining system must be durable and non-toxic to ensure the water

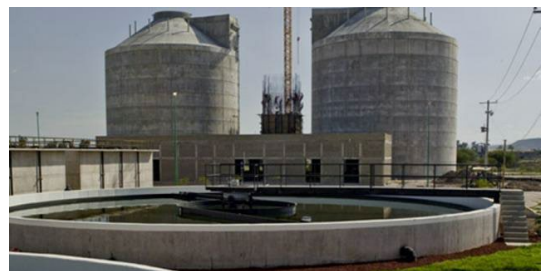

remains uncontaminated, especially when used for irrigation or firefighting. Potable water tanks require linings that are specifically certified for contact with drinking

water. These linings must be non-toxic and resistant to microbial growth to ensure the water remains safe for consumption.

TREATMENT TANKS

Treatment tanks, including desalination and wastewater treatment tanks, have unique requirements. Desalination tanks, which are used to remove salt and minerals from seawater, must have linings that are highly resistant to saline environments to prevent corrosion. Different stages of the desalination process involve various chemicals, so the lining must be chemically compatible with these substances. Wastewater treatment tanks, used for storing and treating sewage and industrial wastewater, require linings that are both chemically and abrasion resistant. These linings must withstand the harsh conditions within the tank, including exposure to various chemicals and solid materials, while preventing leaks and environmental contamination.



CHEMICAL AND SPECIALIZED TANKS

Chemical storage tanks, designed to handle chemically aggressive substances, require linings that are highly resistant to chemical reactions. These linings prevent the stored chemicals from degrading the tank material, ensuring safe containment and preventing leaks. This is crucial for regulatory compliance and environmental protection, particularly in industries dealing with hazardous substances.

APPLICATION-SPECIFIC TANKS

Application-specific tanks, such as canal, towing and conduit tanks, require linings that provide waterproofing and protection for water channels and conduits. These linings must ensure the integrity of the structures by preventing leaks and maintaining stability. They must also be durable enough to withstand

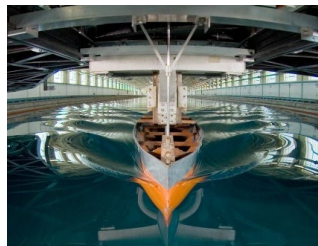

environmental conditions, including UV exposure and varying water flow rates, to ensure long-term performance.



THE IMPORTANCE OF CHOOSING THE CORRECT TANK LINING SYSTEM

Selecting the correct and suitable tank lining system is crucial for ensuring the safety, longevity, and efficiency of storage tanks. The right lining system protects the stored contents and the surrounding environment, helps maintain regulatory compliance, and reduces maintenance costs and downtime. It is essential to consider factors such as the type of tank, the nature of the stored contents, and specific environmental conditions to ensure optimal tank performance. Understanding the specific needs of different tank types and choosing the appropriate lining system ensures tank efficiency, safety, and reliability, whether for potable water, wastewater treatment, or handling aggressive chemicals. Investing in the right tank lining system is a strategic decision that contributes to the sustainability and operational efficiency of companies, safeguarding their assets and promoting long-term success. Therefore, staying informed about the latest advancements in tank lining technologies and collaborating with experts is imperative for making well-informed choices that align with specific requirements and goals.

By choosing Alchimica's tank lining systems based on HYPERDESMO-2K-W, you can ensure versatile and reliable protection for your storage tanks. This system, based on HYPERDESMO-2K-W with additional top coats that you can select, can be implemented in different tank lining systems to meet their specific needs. For additional tank lining systems with difference performance requirements please refer to ALCHIMICA's literature on tank lining systems or contact our technical assistance team at alchimica@alchimica.com

EN 1504-2

EN 1504-2 is a European standard that focuses on surface protection systems for concrete, aiming to prevent deterioration due to environmental exposure, chemical

attack, or physical damage. It covers a wide range of products and aims to enhance the durability and longevity of concrete structures by specifying performance criteria for protection systems. The standard outlines various aspects of concrete repair and protection, including the assessment of existing structures, preparation of surfaces, selection of repair materials, application techniques, and quality control measures.

One key component of EN1504-2 is the assessment of the condition of concrete structures prior to repair and protection activities. This involves evaluating factors such as damage extent, presence of cracks or defects, and environmental conditions affecting the structure. Proper surface preparation is essential for achieving strong adhesion between the substrate and repair materials, maximizing performance and durability.

The standard also provides guidelines for the selection of repair materials based on compatibility, durability, and performance requirements. It addresses application techniques for repair and protection systems, including mixing, placing, and curing procedures. Quality control measures are also a key aspect of EN1504-2, ensuring compliance with specified requirements throughout the repair and protection process. By following these standards, professionals can ensure the durability, safety, and longevity of concrete infrastructure, contributing to sustainable development and the preservation of critical assets.

THE PURPOSE OF DRINKING/POTABLE WATER CERTIFICATION

Drinking water certification for tank lining products is a critical aspect that ensures the safety, quality, and compliance of water storage systems designed for potable use. This certification serves multiple purposes, addressing health, regulatory, and operational concerns, thereby providing assurance to consumers, industries, and regulatory bodies alike.

The primary purpose of drinking water certification is to ensure that the tank lining materials are safe for storing potable water. Potable water tanks are used to store water that is intended for human consumption, cooking, and other domestic uses. Any contaminants leaching from the tank lining into the water could pose serious

health risks. Therefore, certified tank lining products must meet stringent safety standards that confirm they do not release harmful substances into the water. This includes testing for the presence of heavy metals, volatile organic compounds (VOCs), and other potentially hazardous chemicals.

Compliance with national and international regulations is another crucial purpose of drinking water certification. Different countries and regions have specific guidelines and standards for materials that come into contact with drinking water. For instance, in the European Union, the guidelines outlined in EU Directive 98/83/EC set the standards for water quality, which include the materials used in water storage systems. Certification ensures that the tank lining products meet these regulatory requirements, preventing legal and financial repercussions for non-compliance.

Drinking water certification also serves as a mark of quality assurance for consumers and industry stakeholders. It provides confidence that the tank lining product has undergone rigorous testing and meets the high standards necessary for safe water storage. This certification can be a deciding factor for municipalities, industries, and other entities when selecting materials for their potable water storage systems. It ensures that the products are reliable and perform as expected, maintaining the quality of stored drinking water over time.

Certified tank lining products contribute to environmental protection by ensuring that harmful substances do not leach into the water supply and, subsequently, into the broader ecosystem. This is particularly important in areas where water sources are limited, and the integrity of potable water systems is critical for community health and sustainability. By using certified materials, companies and municipalities can prevent environmental contamination and support sustainable water management practices.

Public trust in water supply systems is paramount. Certification of tank lining products for drinking water use helps to build and maintain this trust. Consumers are increasingly aware of and concerned about the safety and quality of their water. Certifications provide transparency and reassurance that the water they consume meets high safety standards. This is particularly important in times of water crises or when addressing public health concerns related to water quality.

For manufacturers of tank lining products, drinking water certification can facilitate access to various markets. Certification demonstrates compliance with local and international standards, which is often a prerequisite for market entry. It also positions the product favorably against competitors, potentially increasing market share. Additionally, certification can reduce the barriers to participating in public tenders and large-scale projects where certified materials are required.

HYPERDESMO-2K-W and HYPERDESMO-HC-POLYUREA-2K by ALCHIMICA are waterproofing membranes used in tank lining systems that have received extensive potable water certification, ensuring they meet the highest standards of safety and quality.

HYPERDESMO-2K-W has been rigorously tested and certified by renowned institutions such as O.T.E.C. and the Standards Institution of Israel, confirming its suitability for use in potable water tanks. The certification process for HYPERDESMO-2K-W involved comprehensive testing to ensure that it does not release harmful substances into the water. This includes ensuring the absence of heavy metals, VOCs, and other contaminants that could compromise water quality. The product's compliance with EU Directive 98/83/EC and other relevant standards underscores its reliability and safety for drinking water applications.

Additionally, HYPERDESMO-2K-W's certification provides quality assurance to consumers and industry stakeholders. The rigorous testing and approval process gives confidence that the product will perform reliably in potable water storage systems, maintaining the integrity and safety of the water over time. This assurance is crucial for municipalities, industries, and other entities that depend on high-quality water storage solutions. By choosing HYPERDESMO-2K-W, companies can ensure they are using a product that not only meets regulatory requirements but also supports public health and environmental protection. The certification facilitates market access and allows participation in public tenders and large-scale projects where certified materials are required, positioning HYPERDESMO-2K-W as a preferred choice in the industry.

In conclusion, drinking water certification for tank lining products is essential for ensuring health and safety, regulatory compliance, quality assurance, environmental protection, and public trust. HYPERDESMO-2K-W by ALCHIMICA exemplifies these standards, providing a certified, reliable solution for potable water storage. Its certification underscores its suitability and safety, making it a strategic choice for various applications requiring high purity and compliance standards. For more information on how HYPERDESMO-2K-W can meet your tank lining needs, contact ALCHIMICA at alchimica@alchimica.com.

PREPARATION

For successful and safe waterproofing applications specific tools and equipment are required. Each application might have different requirements.

Minimum application equipment includes protective clothing, a 1KW slow-speed drill, and a brush, roller, or airless spray machine for mixing and application. Before installing the system, the weather working conditions should be considered in order to ensure the correct and safe application of the system. Overall, avoid extreme cold or hot surface conditions. In case of high heat, contractors may apply the products either in the morning or afternoon. The application temperature range is 5°C to 35°C, with no dew point conditions, a maximum 95% relative humidity, and substrate temperature above 3°C. Store materials cool, tools dry, and avoid application during hot hours.



Substrate: To ensure successful application, substrate preparation is crucial. New concrete should be at least 28 days old, clean, dry, and free of substances that could reduce adhesion. Dust removal is recommended, and Alchimica's primer application can be done over damp concrete.

In case of doubtful conditions, please contact ALCHIMICA's technical assistance for instructions.

REPAIR AND LEVELING MORTARS

REPAIRING

In case any spots on the concrete surface require repairs, filling, and/or smoothing such as large cracks, cavities, or surface levelling, ALCHIMICA's **HYGROSMART®** range of cementitious mortars may be used:



1. **HYGROSMART®-FIX&FINISH** (Single component, rapid-setting shrinkage-compensated, thixotropic, fiber-reinforced, cementitious mortar

applied in a single layer from 3 to 40 mm thick, for repairing and smoothing concrete, certified according to EN1504-03, Type R4 CLASS III), or

2. **HYGROSMART®-BUILDING-45-THIXO** (Single-component, shrinkage-compensated, thixotropic, fiber-reinforced cementitious repair mortar, certified according to EN1504-03, Type R4 CLASS III), or

3. **HYGROSMART®-BUILDING-F** (Single-component, reinforced, quick-setting, cementitious repair mortar with excellent adhesion and mechanical properties, easy application in horizontal/vertical substrates. Long pot life allows the application of thick coats without cracking. CE Certified as Class R3 class III repair mortar according to EN 1504-03.

4. **HYGROSMART®-MAK-FLOW** (Single-component, highly flowable and shrinkage compensated mortar for structural repairs and anchoring, certified according to EN 1504-6: 2006 (Anchoring cementitious mortar for strengthening concrete by installing reinforcing steel) and EN 1504-3: 2005, Class R4(Hydraulic mortar (R4-CC) for structural repair of concrete in building and civil engineering works).

**HYGRO
SMART®**
SYSTEM *Advanced Cementitious Technologies*

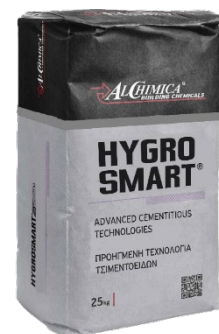

LEVELING

In cases where the concrete needs to be levelled or slopes need to be created prior to the installation of the waterproofing membrane, the following products from the **HYGROSMART®** range can be used, depending on the requirements and desired outcome.

1. **HYGROSMART®-MAK FLOW** (as described above)

PRIMER SELECTION

After checking the weather conditions and having completed the substrate preparation along with any repairs that might be needed, you can start the waterproofing system's build-up with the selection of a suitable primer. ALCHIMICA's primer range provides unique properties for different substrates.

| SUBSTRATE AND CONDITIONS | CONCRETE | HUMID CONCRETE | G YPSUM | METAL STEEL | POROUS CERAMIC TILES | GLASS / GLAZY TILES | PVC MEMBRANES | TPO MEMBRANES | BITUMEN MEMBRANES | LOW TEMPERATURE APPLICATION | VAPOR BARRIER | NEGATIVE PRESSURE / RISING HUMIDITY (Imbals) |
|----------------------------|----------|----------------|---------|-------------|----------------------|---------------------|---------------|---------------|-------------------|-----------------------------|---------------|--|
| PU PRIMERS | | | | | | | | | | | | |
| PRIMER-PU | X | - | - | X | - | - | - | - | - | - | - | - |
| MICROPRIMER-PU | X | - | - | X | X | - | - | - | - | - | - | - |
| MICROSEALER-PU | X | X | X | X | X | - | - | - | - | - | - | - |
| MICROSEALER-50 | X | X | X | X | X | - | - | - | - | - | - | - |
| GEODESMO 50 | X | X | - | X | - | - | - | - | - | X | - | - |
| UNIVERSAL PRIMER-2K 4060 | X | X | - | - | - | - | - | - | X | X | - | - |
| PRIMER T | - | - | - | - | - | X | - | - | - | - | - | - |
| PRIMER W | - | - | - | - | - | X | - | - | - | - | - | - |
| PRIMER TPO/FPO | - | - | - | - | - | - | - | X | - | - | - | - |
| PRIMER PVC | - | - | - | - | - | - | X | - | - | - | - | - |
| WATER-BASED PRIMERS | | | | | | | | | | | | |
| AQUADUR | X | X | X | - | - | - | - | - | - | - | X | X |
| AQUASmart-DUR | X | X | X | - | - | - | - | - | - | - | X | X |
| AQUASmart-PRIMER PU-2K | X | X | - | - | - | - | - | - | - | X | - | - |

ALCHIMICA's primers are designed to secure your waterproofing application in every substrate by strengthening the substrate, stabilizing, and sealing it, offering remarkable adhesion with their respective main membranes and sealants.

SEALING SOLUTIONS



HYPERSEAL® range of PU sealants is essential in sealing applications due to its exceptional adhesion and elasticity, which ensures a durable seal even with the metal's natural expansion and contraction. Its robust formulation offers superior resistance to weathering and UV, making it an ideal choice for both repair and detail treatment in the harsh rooftop environment.

Additionally, HYPERSEAL® sealants provide a waterproof seal that prevents leaks, safeguarding the structure from water damage and corrosion, which is vital for maintaining the integrity of tank lining systems over time. HYPERSEAL®-EXPERT-150 and HYPERSEAL®-EXPERT-60FC are both high-performance polyurethane

sealants from ALCHIMICA, but they serve different purposes and conditions. HYPERSEAL®-EXPERT-150 is a low-modulus sealant, making it ideal for high humidity conditions and ensuring a bubble-free cure, which is critical in large expansion joints. With an impressive elongation of over 700%, it's designed to accommodate significant movement, making it well-suited for dynamic joints. On the other hand, HYPERSEAL®-EXPERT-60FC is a fast-curing sealant with a higher hardness and chemical resistance, recommended for cold environments, tanks and areas where contact with water polluting liquids occurs, such as petrol stations or secondary containment structures. Its fast tack-free time makes it preferable for projects requiring a quick return to service. Both products offer excellent adhesion to a variety of substrates including metal, but their different physical properties make them suitable for specific conditions encountered in metal roof applications. HYPERSEAL® sealants are available in various colors and compatible with a wide range of construction materials in general. Can be easily applied using standard caulking or gun techniques. Choose the suitable HYPERSEAL® sealant for your project requirements.

HYPERSEAL®-EXPERT-150

HYPERSEAL®-EXPERT-150 is a low-modulus expansion and construction joints PU sealant designed to ensure a bubble-free cure even in high temperature and humidity conditions. It exhibits excellent thixotropy, making it suitable for large expansion joints. The ratio width to depth should be 2:1 subject to a minimum depth of 10mm. It cures by reacting with atmospheric humidity, producing a joint sealant with a 50% joint movement accommodation factor, elongation >700% (ASTM D412 / EN-ISO-527-3), and excellent adhesion to a variety of substrates (Adhesion to concrete >20 kg/cm² (>2 N/mm²) ASTM D4541) with or without the use of special primers. The sealant's extrusion rate and tooling remain consistent across various temperature and humidity conditions. HYPERSEAL®-EXPERT-150 is CE certified according to EN 15651-1:2012 (Sealants for Facades) and 15651-4:2012 (Sealants for Floor Joints with Foot traffic). HYPERSEAL®-EXPERT-150 is a highly flexible PU sealant, with elastic recovery of >70% (EN ISO 7389) allowing for the movement and



expansion of structure components, preventing cracks, and ensuring a lasting seal. It adheres to various substrates, making it durable and able to withstand harsh environmental conditions and heavy traffic loads. As a PU sealant, it is also chemically resistant, protecting the structure from corrosion. Because of its excellent chemical and hydrolysis resistance, it is widely used for sealing joints in swimming pools and chemically treated water environments. HYPERSEAL®-EXPERT-150 provides excellent waterproofing, preventing moisture ingress, and has high elasticity, allowing for flexibility and elasticity. It does not shrink as it cures, ensuring no gaps or openings in the sealed joint. Its excellent heat resistance makes it suitable for application where exposure to temperatures $>60^{\circ}\text{C}$ takes place and its resistance to cold allows the sealant to remain elastic even down to -40°C (service temperature

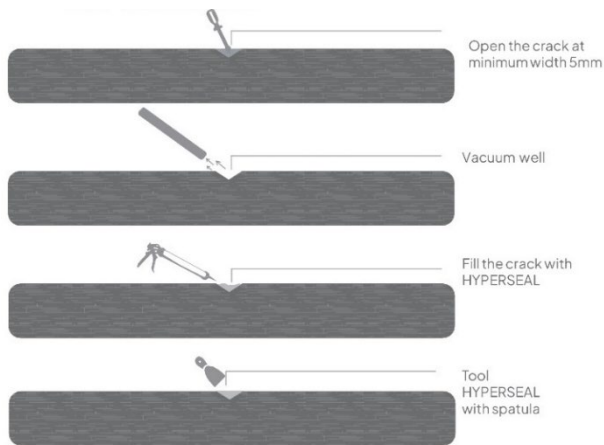

range -40 to $+80^{\circ}\text{C}$). It has tack free time (@ 77°F (25°C) & 55% RH) of 2.5-3.5 hours and a cure rate of 2-3 mm/day, low VOC content, and remains resistant and unaffected by microorganisms, fungi, and algae growth, making it the most versatile PU sealant, usable in a variety of applications.

HYPERSEAL®-EXPERT 60FC

For sealing applications where quick return to service is crucial and chemical resistance is a priority, HYPERSEAL®-EXPERT-60FC is the sealant of choice, offering fast curing times and robust adhesion to a variety of surfaces. HYPERSEAL®-EXPERT 60FC stands out as a fast-curing polyurethane sealant, designed for high-performance sealing, providing excellent early grab adhesion even on challenging substrates such as aluminum, steel, and polycarbonate found in metal roofing applications. With its remarkable chemical resistance and resilience to microorganisms and fungus, it is an ideal sealant for metal roof joints exposed to harsh environmental conditions and those requiring contact with water or water-polluting liquids. Moreover, HYPERSEAL®-EXPERT 60FC assures a durable seal in metal roofing with an exceptional elongation rate over 600%, ensuring that the seal remains intact and flexible, accommodating the natural movement of the metal without compromise, even in the most demanding of sealing and repair scenarios. For metal

roof applications, HYPERSEAL®-EXPERT 60FC offers a swift and dependable sealing solution with its fast-curing properties and high hardness, ensuring quick return to service and long-lasting performance. Its exceptional adhesion capabilities make it suitable for a variety of metal surfaces, including challenging ones like aluminum and steel, eliminating the need for special primers in many cases. The sealant's robust chemical resistance and resilience to environmental factors, including UV exposure, provide a reliable defense against the elements, making HYPERSEAL®-EXPERT 60FC an advantageous choice for both the repair and detail treatment of metal roofs. Its fast curing profile, is making it ideal for cold climates and challenging weather conditions.

METHOD STATEMENT

WATER STORAGE TANK LINING SYSTEMS BASED ON **HYPERDESMO-2K -W.**

Water storage tanks face different types of threats and require excellent sealing and chemical resistance. To prevent cracks that can lead to water leaks, ALCHIMICA's potable water tank sealing system is based on the HYPERDESMO®-2K-W, a unique two-component thixotropic polyurethane membrane.

GENERAL SYSTEM CONDITIONS

EQUIPMENT

For successful and safe applications specific tools and equipment are required. Each application might have different requirements in terms of application and protection equipment.

The following application equipment is at minimum required:

- Protective clothing: Protective overalls, masks, and gloves.
- Mixing equipment: 1KW slow speed drill, 400 or 500 rpm, and suitably sized mixing vessel.
- When stirring (or pigmenting) take care not to introduce air into the fluid, which may result in bubbling on the cured membrane. Stirring can either be done manually or with a low speed (300 rpm) mixer.
- Application equipment: Brush, roller, notched trowel, squeegee, rubber spatula, caulking gun, spatula. Specific airless spray machines can also be used. Caulking guns.
- Extra equipment: Digital scale or other measuring equipment

Products can be applied with a variety of equipment. Please choose the desired



equipment and method of application according to your preferences and experience after consulting the proposed method of application on TDS of the Product.

DISCLAIMER: IMPORTANCE OF EQUIPMENT CLEANING

To maintain the integrity and efficacy of products, especially when working with liquid chemicals, it is crucial to use equipment that is thoroughly cleaned prior to use. Residual chemicals on containers, mixers, or other tools can initiate unintended chemical reactions or cause contamination **when switching between different products**. Such occurrences may lead to product degradation, and project failure. Adherence to rigorous cleaning protocols is essential to prevent these risks. All users must strictly follow the equipment cleaning guidelines specified herein to ensure product performance and project success.

Use clean equipment when switching from different products, to prevent contamination between different products.

WORKING WEATHER CONDITIONS

- Application temperature range: 5°C to 35°C.
- Avoid dew point conditions during application.
- Relative humidity must be a maximum of 95% and substrate temperature must be at least 3°C above measured dew point temperatures.
- Do not apply under rain or snow.
- If temperature is above 35°C, the following guidelines are recommended:
 - Store materials in a cool environment, avoiding exposure to direct sunlight.
 - Keep application tools cool and dry.
 - Try to avoid application during the hottest hours of the day.

SURFACE PREPARATION

THE FOLLOWING FACTORS PRIOR TO APPLICATION SHOULD BE CHECKED:

- ✓ Substrate type and condition.
- ✓ Previous substrate mechanical preparations (sanding, polishing, shot blasting, or milling)
- ✓ Porosity of the surface
- ✓ Existing cracks or damaged areas.

- ✓ In existing dilatation joints, remove old material, clean it, and replace it with HYPERSEAL®.
- ✓ Existing membranes or coatings.
- ✓ The substrates must be both durable and cohesive. Check the substrate for contamination (oil, grease, etc.).

CONCRETE SUBSTRATES

Concrete substrates are used in the construction of roofs and foundations in modern architectural designs. However, because concrete is a porous surface exposed to different climatic conditions, it can absorb water which can then cause damage. Waterproofing is a basic need at almost all stages of construction work, in order to protect structures from the adverse effects of moisture and water ingress. In the case of exposed concrete roofs, it is vital to avoid any water leak in order to prevent any wear and corrosion of reinforcing steel in the concrete structure.

ALCHIMICA's high-quality concrete roof waterproofing and protection systems consist of quality products that hold excellent workability, durability, elasticity, and resistance to weather, chemical, mechanical, and thermal effects, as well as to UV radiation on either flat or sloping roofs.

Standard concrete substrate conditions

- Hardness: R28 = 15 MPa.
- Humidity: W < 10%.
- Temperature: 5-35 °C.
- Relative humidity: < 85%

Metal Substrates

Metal roofing is a common method for industrial or commercial buildings; however, climatic conditions have a great impact in the lifecycle of metal sheets, causing corrosion and damages that lead eventually to water leaks. ALCHIMICA's waterproofing system provides economical and durable refurbishment and protection for metal roofs in inclined and vertical substrates, easy coloring and high resistance to harsh weather effects with excellent UV resistance while preventing from corrosion and damages, extending the life cycle of the metal sheets.

PREPARATION

Proper preparation of the concrete substrate is essential for complete adhesion and successful application.

- New concrete or other cementitious substrates should be at least 28 days old.
- The substrate should be clean and free of loose particles, oil, and grease.
- The substrate should be free of any irregularities. If needed, it should be ground with the appropriate mechanical equipment in order to achieve a flat and sound surface.
- The substrate should be free of dust. Vacuum treatment or/ and high-pressure washing is recommended to remove dust.
- If there are areas/spots that the original metal roof paint (or possibly anodized aluminium colour) has been damaged or worn out, you should remove these old paints or old waterproofing coats (if any), mold and/or corrosion before proceeding with priming.
- Primer application can be done over damp concrete too. But any ponding water should be removed before primer application.
- Metal details should be free of rust, oils, and old paints.
- The surface of PVC pipes should be treated with sandpaper in order to become rough.
- Surface irregularities can be filled with the appropriate HYGROSMART® products.
- For concrete levelling or sloping the appropriate HYGROSMART® products must be used.
- For more information about surface preparation please contact our technical assistance team.

MANDATORY DISCLAIMER BEFORE APPLICATION:

Testing the products to be used in this build-up application on the specific substrate and conducting mock-up tests are essential steps to ensure good adhesion. Mock-up tests replicate real-world conditions and provide a practical way to evaluate the performance of the products in situ. Pull-out tests conducted on these mock-ups help assess the bond strength between the products and the substrate, giving valuable insights into their adhesion capabilities.

By testing the products on the specific substrate and conducting mock-up tests, any potential issues or concerns regarding adhesion can be identified and addressed before full-scale implementation. This proactive approach helps mitigate risks associated with poor adhesion, ensuring the long-term durability and effectiveness of the build-up system.

ALCHIMICA advises the thorough testing of the system to be performed prior to proceeding with full surface application in order to determine the suitability of the system based on project requirements.

SYSTEM PRODUCTS BUILD-UP

| | PRODUCT | CONSUMPTION |
|-----------|-------------------------|---------------------------------------|
| 1. PRIMER | CONCRETE: AQUASMART-DUR | 200-600gr/m2 subject to project needs |



CERTIFIED PRODUCTS

| | | | |
|------------------|--|--|--|
| | METAL/STEEL: MICROSEALER-PU | | |
| | METAL/STEEL: MICROSEALER-50 | 80-100gr/m ² | |
| 2. SEALANT | HYPERSEAL®-EXPERT-150 OR HYPERSEAL-EXPERT-60FC | Subject to project needs | |
| 3. MAIN MEMBRANE | HYPERDESMO®-2K-W | Total consumption: 1,6 -2 kg/m ² | |
| 4. TOP-COAT | (OPTIONAL) | | |

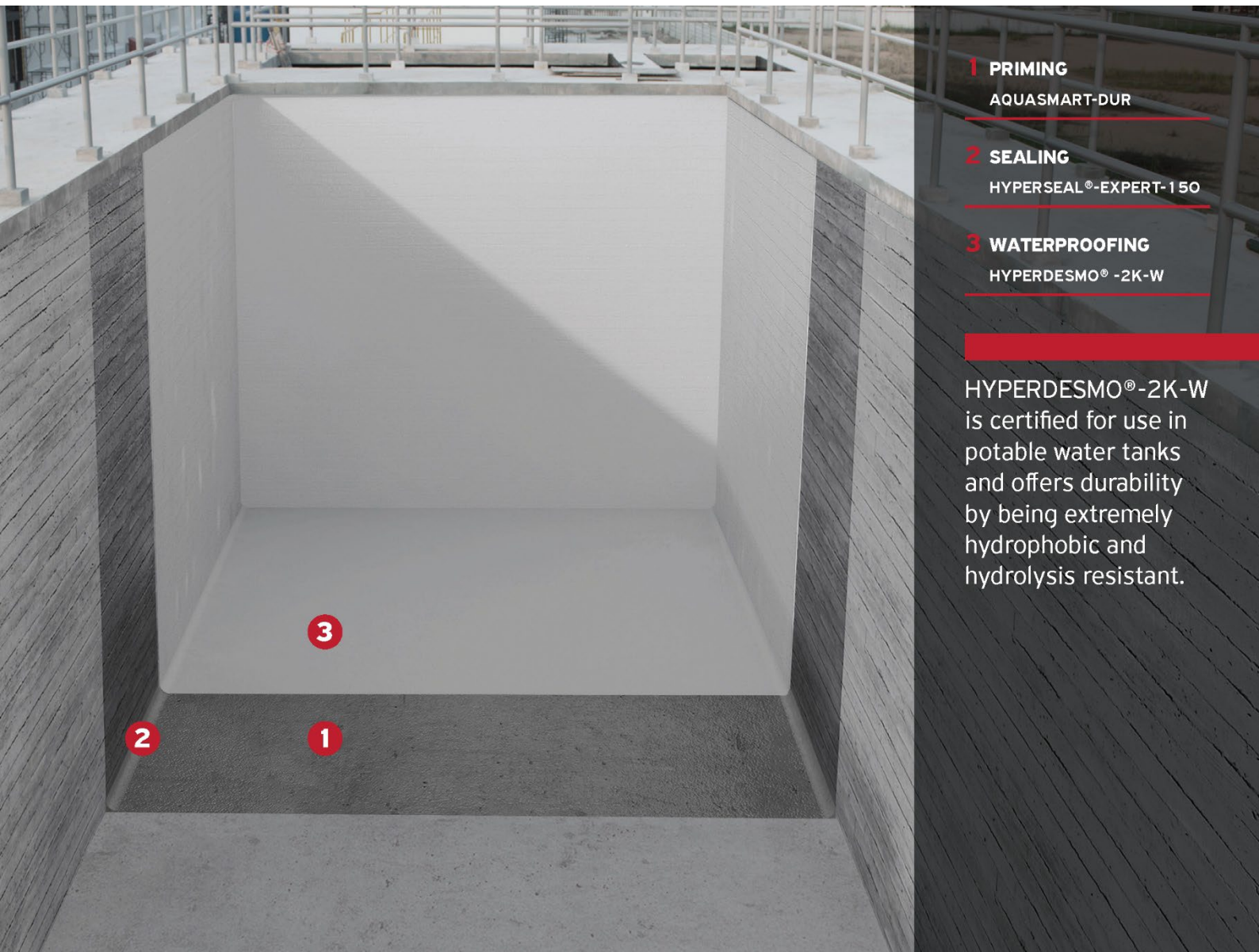
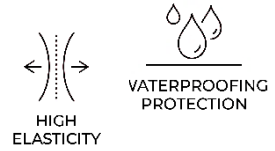
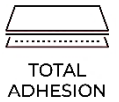

- 1 PRIMING**
AQUASMART-DUR

- 2 SEALING**
HYPERSEAL®-EXPERT-150

- 3 WATERPROOFING**
HYPERDESMO® -2K-W

HYPERDESMO®-2K-W is certified for use in potable water tanks and offers durability by being extremely hydrophobic and hydrolysis resistant.

SUBSTRATE PRIMING



| PRIMER | AQUASMART-DUR / AQUADUR | MICROSEALER-PU | MICROSEALER-50 |
|---|--|-------------------------------------|-------------------------------------|
| CONSUMPTION | - 150-200 gr/m ² - water/humidity barrier –three coats with total cons. of 500-600 gr/m ² | - 80-100 gr/m ² per coat | - 80-100 gr/m ² per coat |
| COMPOSITION | WATER BASED EPOXY | 100% SOLIDS PU | SOLVENT-BASED PU |
| APPLICATIONS METHODS | brush, roller | brush, roller | brush, roller |
| TACK FREE TIME, @ 77 °F (25°C) & 55% RH | 3-5 Hours | 6-12 Hours | 6-12 Hours |
| RECOAT TIME OF PRODUCT WHEN NEEDED | When the material has hardened to the degree where it can no longer be punctured by fingernail 6-24 Hours | 6-12 hours | 6-12 Hours |
| NEXT COAT TIME (HYPERDESMO® MEMBRANE) | Once the colour on the current coat goes from milky white to transparent 6-24 Hours | 24 Hours | 12-24 Hours |
| RECOMMENDED DILUTION | 10% WATER | 5% SOLVENT-01 | X |
| ADDITIVES | X | X | X |
| COLORS | TRANSPARENT | TRANSPARENT | TRANSPARENT |
| POT LIFE | 1 Hour | X | X |
| COMPONENTS | TWO COMPONENTS | SINGLE COMPONENT | SINGLE COMPONENT |

Choose a suitable primer for your project needs and requirements:

For concrete water tanks:

■ AQUASMART-DUR is a medium viscosity epoxy-based primer. It is a water-based epoxy primer and humidity barrier, suitable for application in closed spaces too. It is a two-component product with a 1:1 mixing ratio by volume with zero VOC, low odor, and non-flammability. It has a long pot life while being fast curing, easy to clean, and suitable for concrete and humid concrete too.

Mixing: Mix the two components well manually or using a low speed (300 rpm) mixer.

Application: You choose to apply this primer over a sound concrete surface. AQUASMART-DUR primer will create a slight film sealing the concrete and increasing the adhesion. After the AQUASMART-DUR application, you should wait at least 12 hours to apply the main membrane. The main membrane application has to be done within 48 hours after the AQUASMART-DUR application. AQUASMART-DUR is completely solvent-free and low VOC primer. If a negative pressure humidity barrier is required, increase total consumption of AQUASMART-DUR at a minimum of 500 gr/m² in 3 successive layers (150-200gr/m² per coat)

For metal/steel water tanks:

■ MICROSEALER-PU is a low viscosity, 100% solids PU, polyurethane-based primer. MICROSEALER-PU is free of solvents. Its balanced curing profile makes it suitable for various climates and conditions. It is a single component with excellent wetting, impregnation, and paint-over time properties. It is used for sealing and stabilizing substrates, ensuring good adhesion of the main coat. MICROSEALER-PU is the 100% solids version of MICROSEALER-50 and is ideal for extreme porosity in concrete surfaces where multiple coats of primer may be required. It can be used on both dry and wet concrete, even green concrete, as a primer and low-cost sealing solution, increasing substrate durability and adhesion strength. It can be used successfully on both porous and non-porous substrates.

Mixing: Mix the product well manually or using a low speed (300 rpm) mixer.

Application: You choose this primer if the water storage tank is made from metal/steel. The product is dry to touch in 12 hours on dry cement, and 6 hours on wet cement while the main membrane application can be done 24 hours after primer application.

■ MICROSEALER-50 is a polyurethane based primer/concrete sealer suitable for both porous and non-porous substrates. It is a single component with low viscosity, deep penetration, and slow cure, offering excellent wetting, impregnation, and paint-over time on various substrates. It seals and stabilizes substrates, ensuring good adhesion of the main coat. It is suitable for concrete, humid concrete, metal/steel, porous ceramic tiles, and gypsum boards.

Mixing: Mix the product well manually or using a low speed (300 rpm) mixer.

Application: You choose this primer if the water storage tank is made from metal/steel. Apply the product in well-ventilated conditions. MICROSEALER-50 primer will penetrate, stabilize, and seal the concrete surface in depth. After MICROSEALER-50 application you should wait at least 12 hours in order to apply the main membrane. Apply the main membrane within a maximum of 3 days after primer application.



Notes:

1. If it rains after the primer and before the main coat application, you may need to apply one coat of primer again.
2. More primers are available for special cases, surfaces, and weather conditions.
3. For more information about surface preparation please contact our technical assistance team.

DILATATION JOINTS, INNER ANGLES & SMALL CRACKS

Concrete expansion joints are small gaps in structures designed to prevent cracks, absorb stresses, and allow soil movement. They allow independent movement and thermal expansion without inducing stress. Concrete is susceptible to cracks due to its non-elastic nature, so joints are strategically placed to prevent failure. However, structures with expansion joints are susceptible to water leaks, so waterproofing and applying a durable sealant are essential to maintain flexibility and allow the joint to function properly. All dilatation joints, inner angles, wall-floor connections, cracks, drainage details, pipes, and other elements of equipment mechanically installed must be treated.

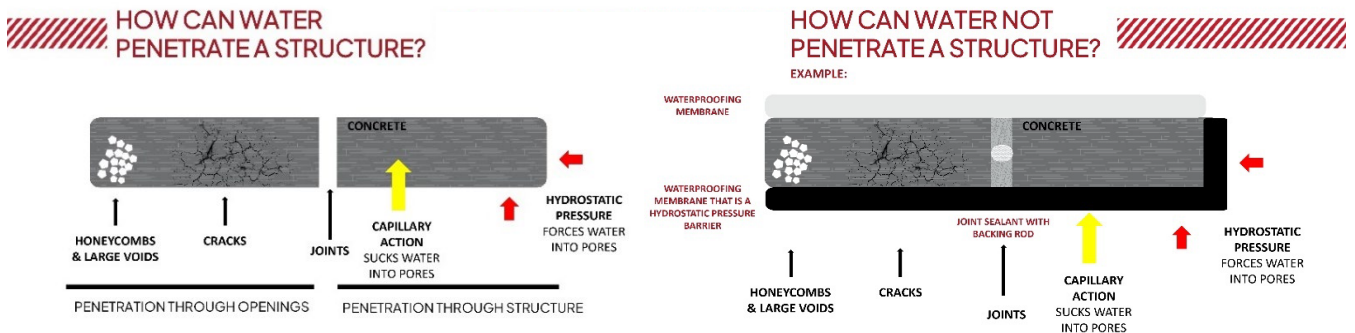

Dilatation joints and inner angles should be treated with **HYPERSEAL®-EXPERT-150** or **HYPERSEAL®-EXPERT-60FC**, polyurethane based sealants.

Clean joints thoroughly, and ensure that no dust, oil, grease, wax contaminants, or silicone remains are present. For many applications, primer is not obligatory. However, in case of application on porous or/and wet substrate the primer is required, as there is a possibility of air bubbles blown into the uncured sealant if the substrate temperature rises.



DILATATION JOINTS & INNER ANGLES TREATMENT



- On concrete: pieces of 25-50m²
- On Screed: pieces of 15-25m²
- Over the junction points where the horizontal surface meets the vertical

After the primer is cured, apply in dilatation joints the right backing material (where needed) – an open cell polyurethane or a closed cell polyethylene backing rod. Be sure that when applying a closed cell polyethylene backing rod, its outer skin is not punctured, as rising temperature may cause bubbles. Backing rod application is important as it ensures the correct width-to-depth ratio and provides a firm backing against which the sealant can be tooled off. Apply the sealant **HYPERSEAL®-EXPERT-150** or **HYPERSEAL®-EXPERT-60FC**.



■ **HYPERSEAL®-EXPERT-150** is a low modulus sealant, formulated to ensure bubble free cure even at very high temperatures and humidity climatic conditions. The product displays excellent thixotropy allowing its use even in very large expansion joints. It cures by reaction with atmospheric humidity to produce a joint sealant with a 50% joint movement accommodation factor and excellent adhesion on many types of substrates (concrete, fibrous cement, mosaic, cement roof tiles, wood, also glass, aluminum,

steel, polycarbonate, etc.). The extrusion rate and tooling of the sealant remain the same throughout a very wide range of temperature and humidity conditions.

■ **HYPERSEAL®-EXPERT-60FC** is a high-performance sealant engineered to deliver exceptional sealing capabilities in diverse environments. This product is specially designed for fast curing and low modulus, making it ideal for applications requiring rapid turnaround without sacrificing quality. The sealant excels in bubble-free curing, even under extreme conditions of temperature and humidity, ensuring a consistent application every time. **HYPERSEAL®-EXPERT-60FC** reacts with atmospheric humidity to form a durable seal with a 60% joint movement accommodation factor, adhering superbly to a variety of substrates including concrete, aluminum, glass, and polymers. It maintains excellent extrusion rate and ease of tooling across a broad spectrum of climatic conditions, demonstrating its versatility in both indoor and outdoor settings.

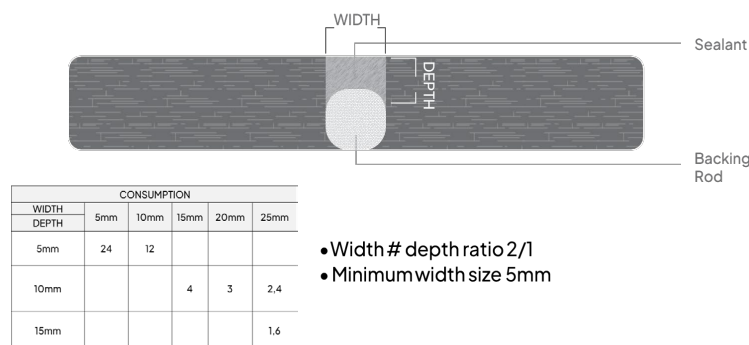

HYPERSEAL®-EXPERT-150 is particularly effective in high humidity and temperature conditions, offering a 50% joint movement accommodation factor and excellent adhesion to a variety of substrates.

HYPERSEAL®-EXPERT-60FC, known for its rapid curing and low modulus, is ideal for fast-paced projects requiring durable and reliable sealing under extreme environmental conditions. Both sealants ensure consistent performance and adaptability across a wide range of climatic conditions, making them ideal for metal roofing applications.

Slide the sealant **HYPERSEAL®-EXPERT-150** or **HYPERSEAL®-EXPERT-60FC** into the sealant dispensing gun, cut off the very end of the sealant packaging, and fit the gun with the nozzle. The nozzle should be cut to deliver the right bead size. Extrude the sealant into the joint ensuring that no air is trapped in the joint. Tooling is recommended immediately after the application of sealant. The ratio width to depth should be 2:1 subject to a maximum depth of 25mm.

NOTE:

- Tool the sealant with a spatula.
- Do not use any solvent, alcohol, or soap to smooth the material.
- Clean tools and equipment first with a paper towel and then using SOLVENT-01.

POLYETHYLENE BACKER ROD

Special backer rod made of extruded polyethylene for joints where HYPERSEAL® sealants will be used.



| SIZE | PACKAGING |
|------|-----------|
| F6 | 1500m |
| F10 | 680m |
| F15 | 250m |
| F20 | 180m |
| F25 | 100m |
| F30 | 100m |
| F40 | 100TEM |
| F50 | 65TEM |

MAIN WATERPROOFING MEMBRANE

HYPERDESMO-2K-W is an advanced, two-component, solvent-free, thixotropic, 100% solids polyurethane coating, with exceptional elastomeric properties. This product is designed to create a durable, flexible, and completely impermeable membrane after polymerization, making it an ideal solution for waterproofing and protecting various surfaces, particularly water storage tanks. Certified for potable water tanks, HYPERDESMO-2K-W ensures safe usage in environments storing drinking water.

| | |
|---|--|
| CONSUMPTION | 0.7 kg/m ² per coat Total: 1.4-1.8 kg/m ² |
| APPLICATIONS METHODS | brush, roller |
| TACK FREE TIME, @ 77 °F (25°C) & 55% RH | - |
| APPLICATION OVER PREVIOUS COAT (PRIMER) | Depending on the primer curing time |
| RECOAT TIME OF PRODUCT | 6-48 Hours |
| NEXT COAT TIME (TOPCOAT) | 6-48 Hours |
| POT LIFE | @ 25 °C 20-30 min |
| COLORS | OFF WHITE |
| COMPONENTS | TWO COMPONENTS |

HYPERDESMO-2K-W boasts excellent resistance to both acidic and basic conditions, and it remains effective even in chlorine-treated water. Its ability to form a compact, shiny membrane inhibits the growth of microorganisms and bacteria, which are common problems with cementitious or other highly porous materials. The product's hydrophobic nature and resistance to hydrolysis further enhance its protective capabilities, ensuring long-lasting performance in a wide range of environmental conditions. The technical specifications of HYPERDESMO-2K-W highlight its robustness and versatility. It performs well across a broad temperature range from -40°C to 90°C and offers good chemical resistance. HYPERDESMO-2K-W is a top-tier solution for waterproofing and protecting potable water tanks and other storage tank structures. Its ease of application, combined with its strong, flexible, and impermeable membrane, ensures reliable performance and long-term durability, making it a preferred choice for various industrial and commercial applications

Mixing: Use a low speed (300 rpm) mixer.

Pot life: once the two components have been mixed is 30 min in 20 °C. It can be increased by:

1. Keeping the mix in a cooler place, away from the sun,
2. Pouring the mix on the floor, in order for it to cool down, and then spreading it,
3. Pouring the mix in a separate wide and shallow container.

Application: HYPERDESMO-2K-W can be applied efficiently in a single coat of 1.4 kg/m² on horizontal surfaces. For vertical surfaces, achieving the same total consumption requires two successive coats of 0.7 kg/m² each. This application method is designed to provide thorough coverage and optimal protection. The product's excellent adhesion properties allow it to bond effectively with various substrates, including concrete, steel, and prefabricated materials.

Disclaimer: This system is recommended for well-ventilated water tanks only. It should not be applied in closed/ bad ventilated tanks.

TYPES OF APPLICATIONS

APPLICATION:

VERTICAL SURFACES:

- Per coat 0.7 kg/m².

HORIZONTAL SURFACES:

- per coats of 0.7kg/m² or
- You can apply the full consumption in one single coat up to 1.4 Kg/m²

Apply more coats depending on project requirements and system build-up.

- Minimum total consumption: 1.4kg/m².

TOPCOAT

HYPERDESMO-2K-W can be used, without the need of any topcoat, for drinking water tanks and several other types of domestic water tanks. On tank surfaces with direct exposure to sunlight, HYPERDESMO®-2K-W will discolor. This is purely visual; it does not affect the performance of the product. For aesthetic needs and discoloration protection a topcoat is recommended.

For industrial and waste water tanks a topcoat protection is recommended. For additional tank lining systems with difference performance requirements please refer to ALCHIMICA's literature on tank lining systems or contact our technical assistance team at alchimica@alchimica.com

CLEANING

Clean tools and equipment first with paper towels. Tools and equipment should be cleaned immediately using SOLVENT-01 (or water for water-based materials). Rollers will not be re-usable.

REPAIRS, OVERLAPS AND MAINTENANCE PROCESS

Concerning any future repairs and general maintenance of the water tanks, ALCHIMICA S.A. recommends the following actions to take place:

1. Upon emptying of the tanks a thorough investigation of the quality of the membrane must be carried out. Specifically, the membrane should be completely intact with a uniform thickness of HYPERDESMO-2K-W over the whole tank surface. There should be no holes, punctures, loss of adhesion of membrane, or in the case that original application not carried out according to specifications, uneven consumption of material.
2. In the case that for whatever reason repair work with HYPERDESMO-2K-W must be done, the surfaces must be cleaned thoroughly with either liquid industrial detergents or if this is not possible by mechanical means. This is to ensure the removal of any deposits on the membrane that will create problems of adhesion of subsequent coats.
3. In the case of detection of areas of concrete that were immersed in water and that were missed in the original application of HYPERDESMO-2K-W, the substrate must be dry before application of primer and main coating.
4. In the case of re-coating with HYPERDESMO-2K-W, application of ALCHIMICA's epoxy-based primer AQUASMART-DUR must be carried out on all surfaces including any bare concrete. This will ensure adhesion of old and new sealing as well as sealing over old HYPERDESMO-2K-W. Sanding of the existing membrane will help achieving sufficient adhesion prior to the application of AQUASMART-DUR.
5. Regarding any repair of the main coating, after application of AQUASMART-DUR, any patching should be done over a larger diameter than the actual defect itself, overlapping the existing non-defective coating by 15-20cm.
6. Tanks must have sufficient ventilation throughout their working life. This will hinder the formation of microorganisms that although do not attack the membrane itself, will damage the concrete from beneath.

For any further information please contact our technical department at:
alchimica@alchimica.com

REFERENCES

ALCHIMICA throughout the years, has a collection of completed projects from around the world. On our website, you can find where we have provided a variety of solutions and expert know-how, in case studies ranging from the smallest roof to the largest project. www.alchimica.com



HEALTH AND SAFETY

The system proposal contains volatile flammable solvents. Apply in well-ventilated, no-smoking areas, away from naked flames. In closed spaces use ventilators and carbon-active masks. Keep in mind that solvents are heavier than air, so they float near the floor. The MSDS (Material Safety Data Sheet) of the products are available on request.

This handling safety advice is required for the implementation procedure as well as in the pre- and post-exposure to the loading machinery.

- Protect your lungs by using an air-purifying respirator when handling or spraying.
- Use rubber gloves to protect your skin and remove them promptly after contamination. Wear clean undergarments. After work and before eating, drinking, or smoking, thoroughly wash your hands with soap and water.
- Wear safety goggles to protect your eyes and face from splashes and airborne particles.
- Waste generation should be avoided or reduced.
- Incinerate under well-controlled conditions in line with local and national rules and regulations.
- Re-occupancy of the work site without respiratory equipment is limited to 24 hours if proper ventilation for the sprayed area is provided.
- Contractors and applicators must follow all applicable and necessary storage and safety regulations.
- In any case, review the system's material and safety data sheets.

PRECAUTIONS AND VARIATIONS.

The purchaser must determine the suitability of the products for the intended use and assume all related liabilities and risks. This information, recommendations, and any additional technical advice are given in good faith and are based on ALCHIMICA's present knowledge and experience of the products when properly stored, handled, and applied under normal conditions according to ALCHIMICA's recommendations.

However, ALCHIMICA assumes no liability for providing such information and advice including the extent to which such information and advice may relate to existing third-party intellectual property rights, especially patent rights, nor shall any legal relationship be created by or arise from the provision of such information and advice. ALCHIMICA reserves the right to change at any time the properties of its products. The purchaser of the product(s) must test the product(s) suitability for the intended application and purpose before proceeding with a full application of the product(s).

The performance of the products build up described herein should be verified by testing and carried out by qualified experts.

NOTE: This method statement is offered by ALCHIMICA as a 'summary proposal' for **POTABLE WATER TANK LINING SYSTEM BASED ON HYPERDESMO-2K-W**. For projects' particularities and more precise technical support, please contact ALCHIMICA at: alchimica@alchimica.com

Please consult the above-referred products' technical data sheets (TDS) and safety data sheets (SDS). Under any circumstances, ALCHIMICA does not assume any responsibility for the performance of the waterproofing system given the conceptual flaws of the existing build-up. Imperative for the performance of the system is the correct cleaning, inspection, and maintenance of the waterproofing system. For projects' particularities and more precise technical support, please contact ALCHIMICA at: alchimica@alchimica.com

Where alternative systems are to be used, these must be submitted to ALCHIMICA for approval. ALCHIMICA will not accept responsibility or liability for variations to the above under any other condition.

LEGAL NOTES AND CITATION

- This is a technical document, without legal value.

- POTABLE WATER TANK LINING SYSTEM BASED ON **HYPERDESMO®2K-W**
- No liability or warranty of product performance is created by this document.
 - All the information included is collected from materials TDS, DoP, and certificates available at the moment of publishing.
 - ALCHIMICA S.A. does not guarantee the accuracy of its instructions or specifications, nor do we assume any responsibility for damages resulting from the use or reference of the information provided. The company reserves the right to change the properties of its products at any time, and the current version of the technical data sheet is available on the website www.alchimica.com/en
 - Appropriate Technical Documentation and/or Specific Technical Documentation: The performance of the products
 - identified in the DoP files conform with the set of declared performances. This declaration of performance is issued in accordance with Regulation (EU) No 305/2011, under the sole responsibility of the manufacturer.
 - It is recommended to check the TDS and MSDS of all the materials before use and application.
 - The use of these materials and products is beyond the scope and control of ALCHIMICA.
 - Proper application is the responsibility of the Buyer and/or Contractor.
 - It is forbidden to reproduce it in any form, totally or partially.
 - All the above written and provided is subject to the terms and conditions of sale and marketing of ALCHIMICA S.A.

ALCHIMICA S.A.

7, Lampsakou Str.

115 28, Athens Greece

Tel.: +30 214 4167 700

Fax: +30 214 4167 701

www.alchimica.com